

# Specification

Prepared	Checked	Approved

Acceptance	Confirm	Approve

- 2835 SMD
- 120 LEDs/M
- LED Strip
- DC 24V
- IP 20
- 2 Years warranty

**Model:** ☉ RL05C0TC-L-S

5000\*5mm, 120LEDs/m 2835chips, bare board series, constant voltage, 24V, long flexible LED strip (White 8W/m)

**Features:**

- ☉ 2835 SMD LED beads, strong reliability;
- ☉ Single LED cutting, convenient;
- ☉ Strong adhesive back tape for easy installation;
- ☉ 24V safe voltage, can be cut and used;
- ☉ 5mm wide product, easy to install in profiles.

**Product pictures :**



**Application :**

- ☉ This product is suitable for use in hotels, KTVs, homes, cabinets, courtyards, etc., for outlining, ambient lighting, decorative lighting, and other purposes.

**Warranty :**

- ☉ Warranty 2 years or 9000 hours, whatever occurs first.

**Basic parameters :**

P/N	LED Color	CCT(K) WL(nm)	CRI	SDCM	Beam Angle (°)	Luminous Flux (lm/m)	Luminous Efficiency (lm/W)	Working Voltage (V DC)	Working Current (mA)		Power (W)	
									1m	5m	1m	5m
RL05C0TC-L-S	White	3000K	≥90	≤5		720	90					
	White	4000K	≥90	≤5	≥115	765	96	24	333	1415	8	34
	White	5000K	≥90	≤5		775	97					

**Other parameters:**

P/N	IP grade	Operating Temperature (°C)	Operating Temperature (°F)	Storage Temperature (°C)	Storage Temperature (°F)	Standard length (m)	Max. Cascading Length (m)	Chip Qty (pcs/m)	Weight (g/m)
RL05C0TC-L-S	IP20	-25~+60	-13~+170	-25~+70	-13~+158	5	5	120	9.6

Notes:

- (1) Testing environment temperature: 25±2°C [77±3.6]°F
- (2) The actual data of each single product may differ from above typical data which are subject to change without prior notice;
- (3) The above "--" means the parameters are not required temporarily.

**Profile Drawings:**

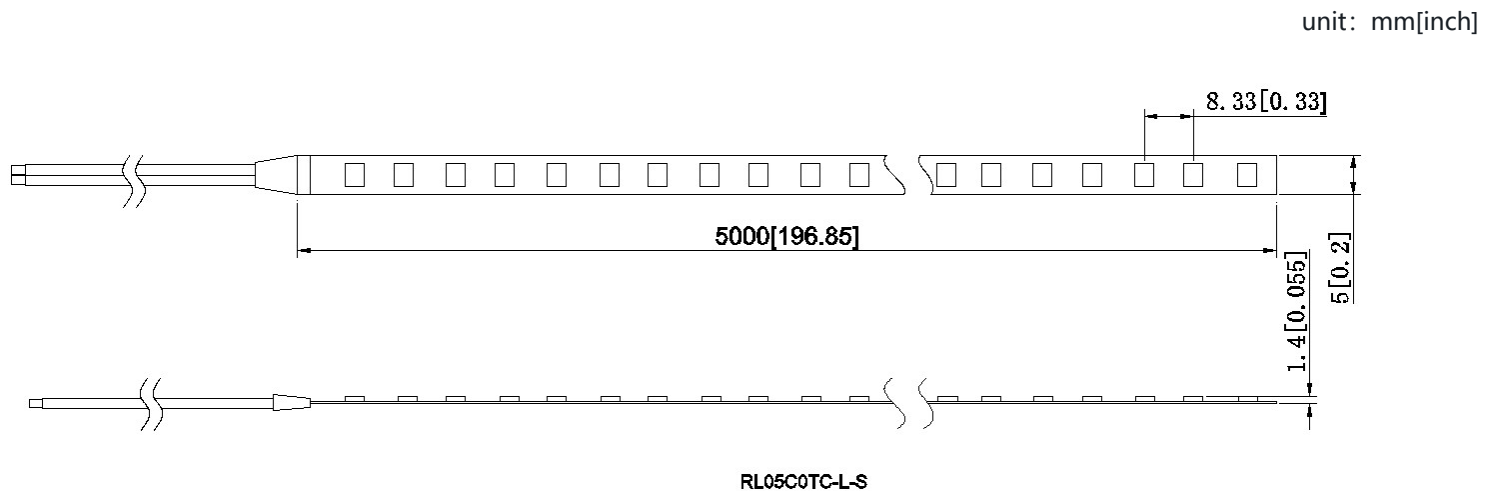

**Packaging Information:**

P/N	Qty (m/reel)	Qty (m/carton)	Total Qty (m)	Total weight		Outer carton size					
						length		width		height	
				(kg)	(lb)	(mm)	(inch)	(mm)	(inch)	(mm)	(inch)
RL05C0TC-L-S	5	300	300	5.1	11.3	405	15.9	256	10.1	238	9.4

Notes: Above qty and weight of packing is only for the packing shown in the picture, which might be different from other packing modes, thus for actual qty and weight please refer to actual samples.

Packaging Diagram:

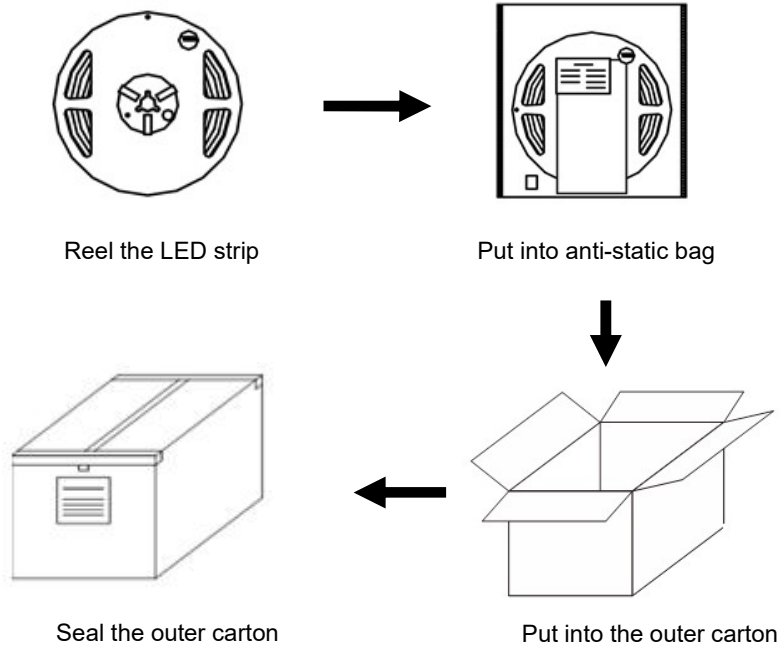

Connection Instruction:

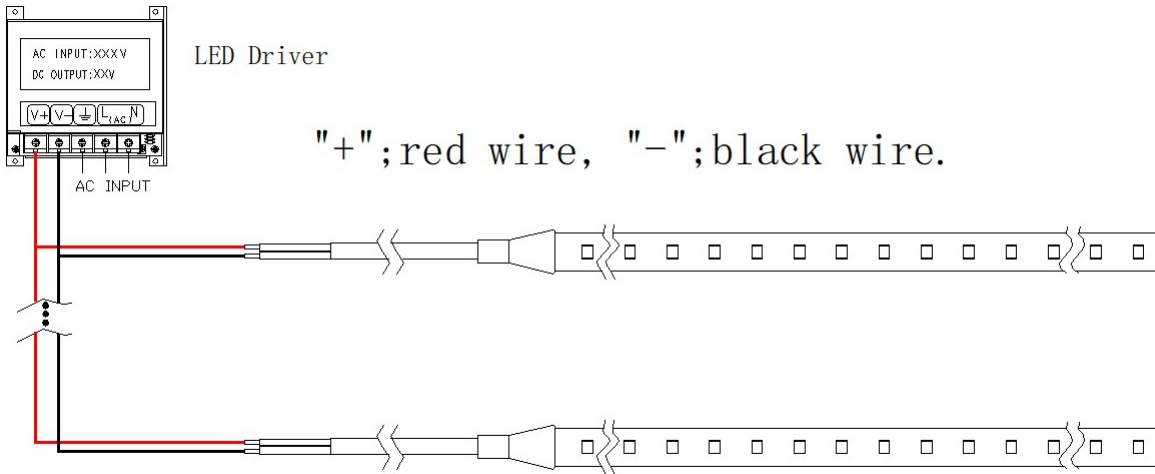

Parts and tools:



Led Strip



Electrical Drill & Drilling Bit

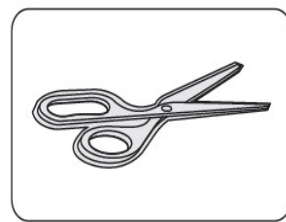

Scissors

Installation steps and note:

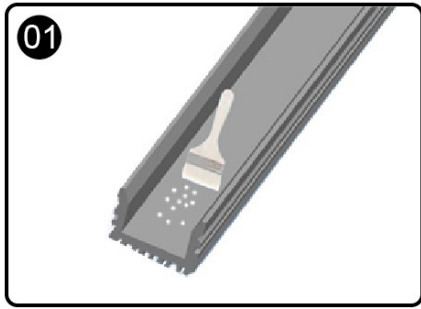

- To install on the surface of the debris to clean up, to ensure that the surface clean

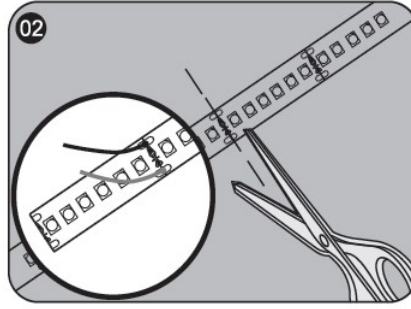

- Measure the length of the strips and cut off the length you need at the cutting marking.

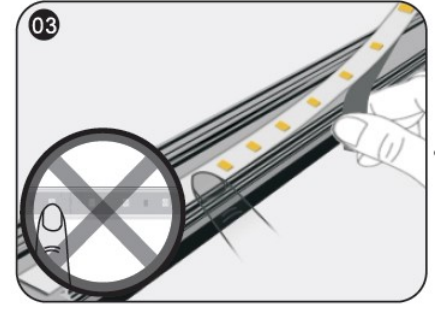

- When installing the strip, please attach the strip as soon as removing the paper. Please do not removing all the paper before attaching the strip.



- Stick Mylar tape to isolate the cutting position from the bottom of profile inner slot to avoid short-circuit;

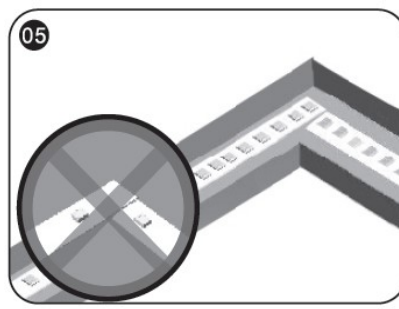

- The above marking should be shown at the installation corner  
 △note: No bending the strip into a right angle ; No twisting it to stick on the mounting surface.

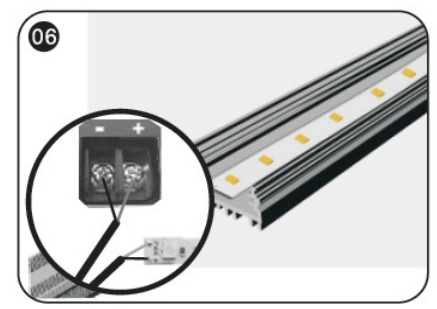

- Connect strip wires to the output terminal of power supply, and dispose with waterproof, insulation short-circuit and anti-corrosion protection at both the wire joints and the cut section of your strip (if any)

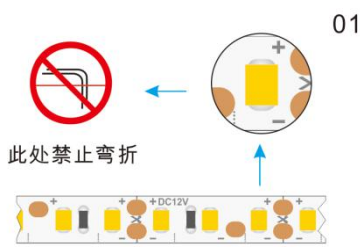

- Do not bend at the LED position.



- Do not twist the strip.

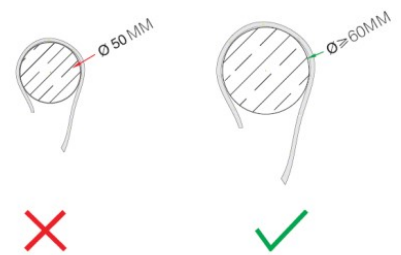

- Do not wind the strip with a diameter <5cm.

**Trouble shootings:**

The fault phenomenon	Possible reasons for	The solution
All the light not bright	1. Mains no power supply	To connect to the mains correctly
	2. After the switch power supply output open circuit or short circuit power supply automatic protection	Troubleshooting and feed power again
	3. The polarity of power supply reverses	Check the wire connection status, ensure correct connection of polarity is correct.
Part of the strip is failed to work	1. Part of switch power supply is disconnected.	Check the power supply system, troubleshooting
	2. The circuit of part of the strip malfunctions	
	3. The polarity of strip reverses	Correct connection
LED brightness is different or not enough brightness LED	1. The power supply is overloaded	To use a power supply with higher power
	2. The power loss of power supply or other circuits is too much.	Ensure that the working voltage of the strip is within $\pm 5\%$ of rated voltage 1. Cut off the cable of power supply and strip or use wire with larger diameter. 2. Ensure every cascading should be within the permitted cascading and the length of every cascading is similar.
	3. The cascading is over the permitted cascading	.Ensure every cascading should be within the permitted cascading
The LED flashing LED	1. The connection is poor contact	Find the poor contact points and improve it.
	2. Failures in power supply.	Replace the switching power supply

**Declaration:**

- ⊙ If the external flexible cable of light box is damaged, please replace it by its manufacturer or its service agent or qualified person to avoid a hazard.
- ⊙ The specific installation and cautions please refer to the user manual.
- ⊙ The given data in this specification is based on our standard product. There may be existed slight difference compared with actual products.
- ⊙ All Illustrations in this specification are for reference only.
- ⊙ This product is subject to change or modify without prior notice
- ⊙ RISH HANG OPTO OELECTRON NICS CO., LT TD reserves the right of final explanation for this specification.

End

**Rishang Optoelectronics Co.,Ltd** (stockcode: 002654)

Website

Official Wechat

Add: Floor 1-8, North Side, 701, Mason Building, No. 2519, Guangqiao Avenue, Fenghuang Community, Fenghuang Street, Guangming District, Shenzhen City, G.D. China  
Tel: +86-755-36988588 E-mail: [info@ledlamps.com.cn](mailto:info@ledlamps.com.cn)  
Web: [www.ledlamps.com.cn](http://www.ledlamps.com.cn)

