

Top Bend Neon – RX2CC0TC-A

1616-24V Flexible Top Bend Planar Neon Strip For IP66 Application



Technical Application Guide



Version: 7.0

Issued on: August 16th, 2023

RX2CC0TC-A

1616-24V Flexible Top Bend Planar Neon Strip of IP66

1616-24V Flexible Top Bend Planar, 14W/m constant voltage Neon Strip. Neon is featured in IP66 protection and great UV resistance, so it can be exposed to intense sunlight without yellowing and aging for a long time.

The high light transmission further empowers it to be suitable for sign lighting, indoor and outdoor decorative lighting, and building outline lighting.

- Dual color eco-friendly silicone material adopted.
- Linear light and dot-free.
- Large top bending angle, flexible cutting.
- Pure copper FPC, reliable quality.
- IP66 protection and good UV resistance.
- Resistance against Acid and alkali corrosion.

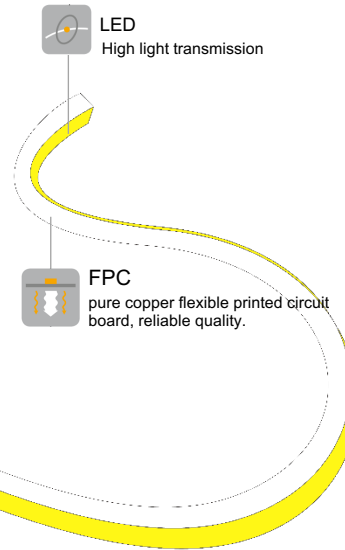

Reliability

Category	Item	Reference Standards	Test Conditions	Result
IP grade test	Waterproof test	GB/T 4208IEC 60529	25 ± 2°C @ ≤65%RH	IP66
	Dustproof test	GB/T 4208IEC 60529	25 ± 2°C @ ≤65%RH	
Safety test	Flame retardant test	GB7000.1IEC 6059801	25 ± 2°C @ ≤65%RH	Pass
Environmental test	Hi-Low temperature cycle test	GB/T 2423.22IEC 60068-2-14	-40°C@30mins → 25°C@5mins → 85°C@30mins → 25°C@5mins → -40°C@30mins; 168 hours	Pass
	Thermal shock	GB/T 2423.22IEC 60068-2-14	-40°C → 70°C 100 circles	Pass
	Hi-temperature storage test	GB/T 2423.3IEC 60068-2-78	Ta=80°C	Pass
	Low-temperature storage test	GB/T 2423.1IEC 60068-2-1	Ta=-40°C	Pass
	Hi-temperature & Hi-Humidity Life	GB/T 2423.2IEC 60068-2-2	Ta=70°C @ RH=90%	Pass
	UV test	GB/T 16422.3ISO 4892-3	50 ± 3°C, 10 ± 5%RH, Exposed at radiation 5 hours, spaying water 1 hour in 20 ± 3°C, 4 circles	Pass

RX2CC0TC-A

1616-24V Flexible Top Bend Planar Neon Strip For IP66

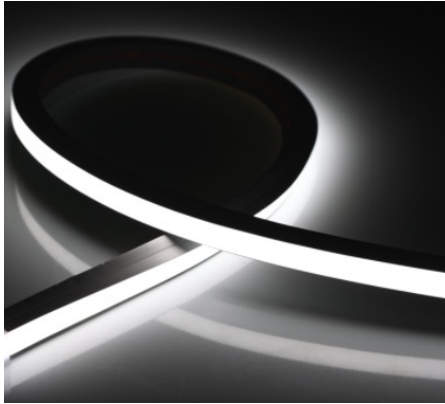

1616-24V Planar Neon Strip

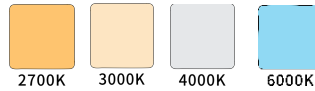

3-year warranty

P/N	Dimensions (L x W x H)		Cutting unit		Number of LEDs	
RX2CC0TC-A	5000*16*16mm	196.85*0.63*0.63inch	50mm	1.97inch	120/m	36/ft

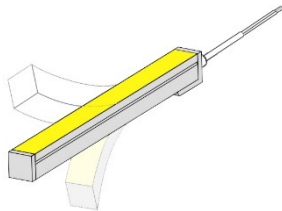

Top Bend

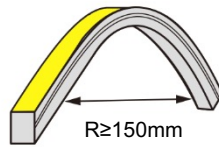

Bending Diameter

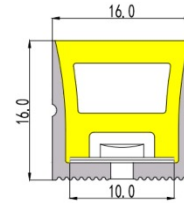

Sectional view

Unit: mm

Basic Parameters :

P/N	LED Color	CCT (K) WL (nm)	CRI	Beam Angle(°)	Luminous Flux (Lm/m)	Working voltage (V DC)	Working current (mA)		Power (W/m)	
							1m[39.37i n]	5m[196.8 5in]	1m[39.37i n]	5m[196.8 5in]
RX2CC0TC -A	White	2700	≥90	≥120	448	24	583	2583	14	62
RX2CC0TC -A	White	3000	≥90	≥120	490	24	583	2583	14	62
RX2CC0TC -A	White	4000	≥90	≥120	532	24	583	2583	14	62
RX2CC0TC -A	White	6000	≥90	≥120	532	24	583	2583	14	62

P/N	Qty (m/reel)	Qty (m/carton)	Total Qty (m)	Total weight		Outer carton					
				(Kg)	(lb)	length		width		height	
				(mm)	(inch)	(mm)	(inch)	(mm)	(inch)	(mm)	(inch)
RX2CC0TC-A	5	50	50	15	33.07	385	15.157	385	15.157	425	16.73

P/N	IP Grade	Operating Temperature		Storage Temperature		Standard length		Max. cascading length		LED Qty (pcs)	Weight	
		(°C)	(°F)	(°C)	(°F)	(m)	(inch)	(m)	(inch)		(g/m)	(lb/m)
RX2CC0TC-A	IP66	-25	13	-25	13	5	196.85	5	196.85	120	225	0.496
		~	~	~	~							
		+60	+140	+70	+158							

RX2CC0TC-A

1616-24V Flexible Top Bend Planar Neon Strip of IP66

Profile Drawings

Unit: mm [inch]

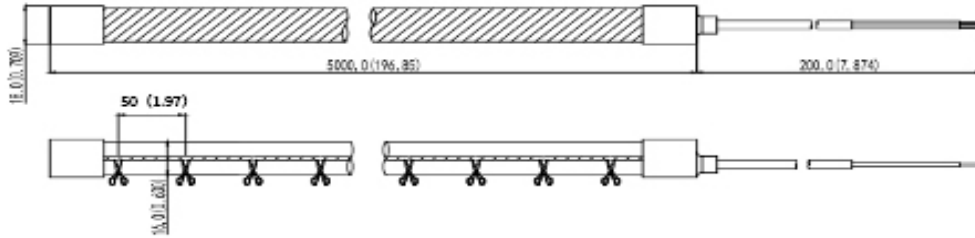

Light Distribution

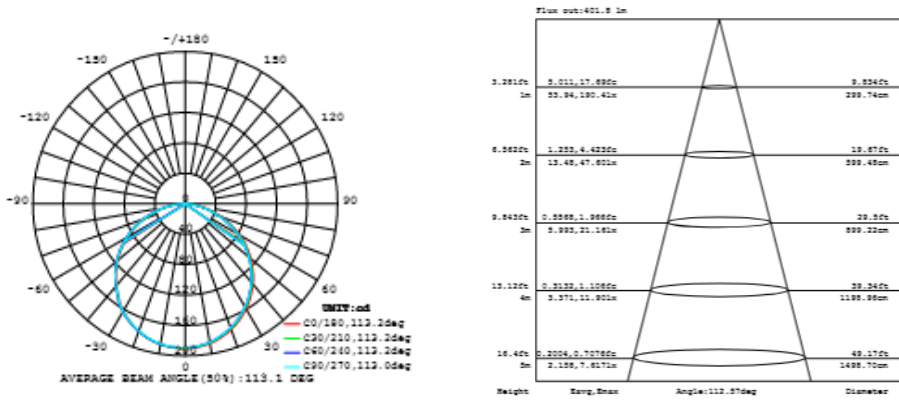

Packaging Diagram

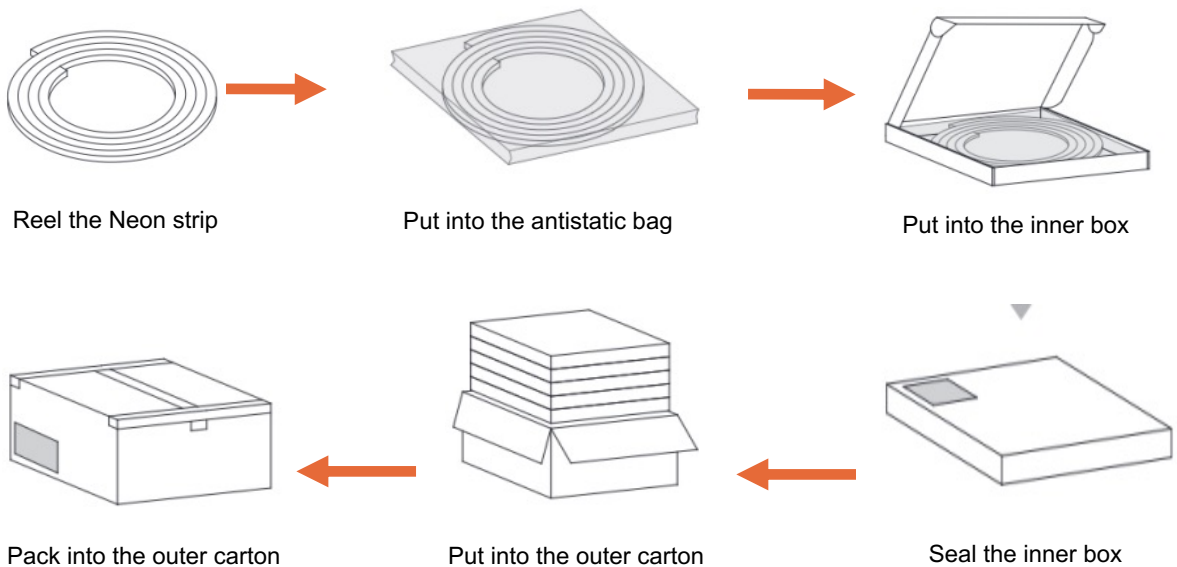

RX2CC0TC-A

1616-24V Flexible Top Bend Planar Neon Strip of IP66

Connection Instruction

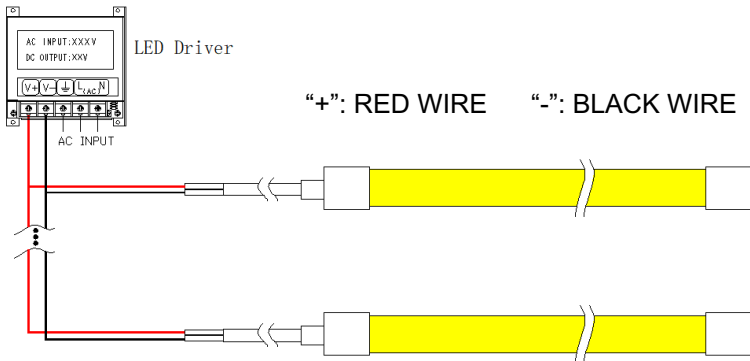

Note: Please make sure the poles of the product are correctly connected to those of the power supply.

Installation of clip

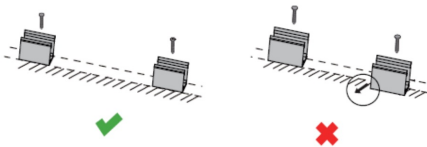

Use screws to fix the clips or carriers on the mounting position.
△Notes: 3 clips can be used for 1m.

Installation of carrier

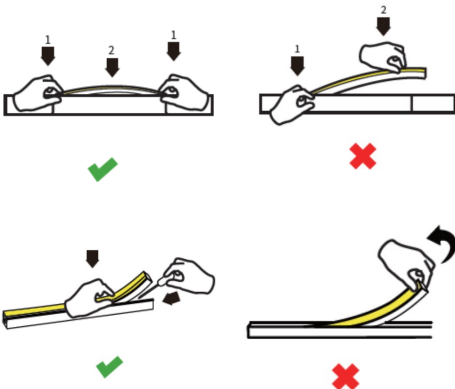

1. When install the Neon, install it from both ends at the same time, install from one direction is prohibited.

2. Use tool to disassemble carefully, and do not pull the Neon directly.

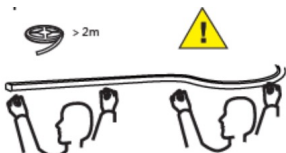

△Notes: If the length of Neon is over 2m, it is recommended to install by two persons.

RX2CC0TC-A

1616-24V Flexible Top Bend Planar Neon Strip of IP66

Attention

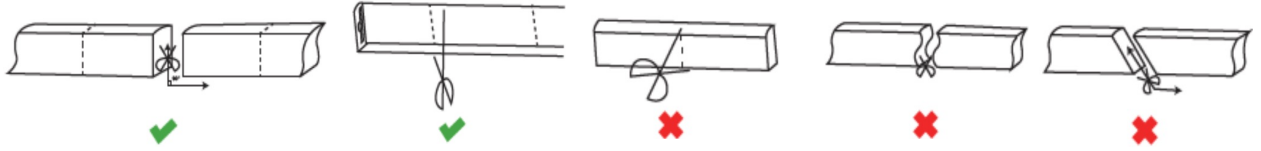

Cutting Methods

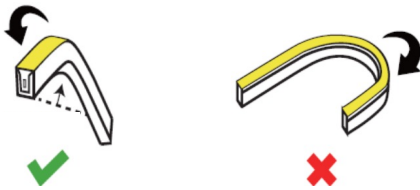

Do not bend the Neon less than 150mm.

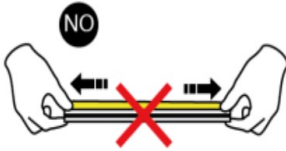

No stretching.



No twisting.

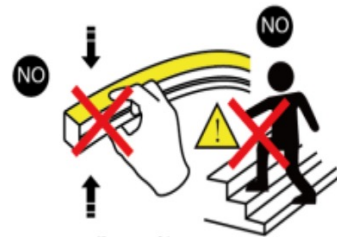

No trampling.

RX2CC0TC-A

1616-24V Flexible Top Bend Planar Neon Strip of IP66

Troubleshooting

Malfunctions	Possible Causes	Solutions
All LEDs Stopped Working	The power supply did not connect to power grid.	Power on.
	Broken-circuit or Short-circuit.	Troubleshoot the problems and power on again.
	The wires of strips connect to the power supply terminal reversely.	Check the connection and ensure the polarity of the wires is connected correctly.
Part of LEDs Stopped Working	Part of power supplies have output failure.	Check the power supply system.
	Part of wires of strips have breakdown.	
	Reverse connection of polarity.	Correct connection.
LEDs Too Weak or Uneven	Overloaded power supply.	Replace it with a powerful one.
	Excessive power loss of the circuit or the power loss of each circuit differs a lot.	Ensure working voltage of strips is within $\pm 5\%V$ of rated voltage. 1. Shorten the length of wires between the first strip and power supply or replaced with wires with larger diameter. 2. Ensure the cascading qty of each circuit does not exceed the allowed range and is well distributed.
	Excessive cascading qty in series.	Adjust the cascading qty for strip to ensure the qty for each electrical circuit is within the maximum cascading qty.
LEDs Flickering	Exposed or loose joints of wires.	Find out and tackle malfunction immediately.
	Failures in power supply.	Replace it with a new one.

Declaration

- If the external flexible cable is damaged, please replace it from its manufacturer, service agent, or qualified person to avoid a hazard.
- For the specific installation and cautions, please refer to the user manual.
- The given data in this specification is based on our standard product. There may exist slight differences compared with actual products.
- All Illustrations in this specification are for reference only.
- This product is subject to change or modification without prior notice.
- RISHANG OPTOELECTRONICS CO., LTD. Reserves the right of a final explanation for this specification.

Revision History

Version	Revised by	Revised item	Release date
V7.0	Wei Fan Song	first release	June.04.2023