

ZigBee 2-Gang In-wall Switch



Important: Read All Instructions Prior to Installation

Function introduction

2 channels switch input, to control 2 channels load separately

“Reset” Key: for network pairing, touchlink, factory reset of the switch

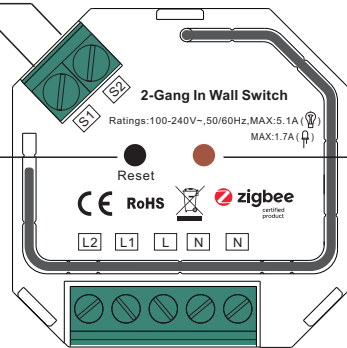

LED indicator: stays off if the device is not added to a ZigBee network, stays solid on after the device is added to a network. Same indication as connected load when commissioning the device: network pairing, touchlink, factory reset

2 channels load output AC power input

Product Data

Input Voltage	Output Voltage	Output Channel	Max. Load	Size(LxWxH)
100-240VAC	100-240VAC	2 Channels	Resistive load: max. 5.1A/CH Capacitive load: max. 1.7A/CH	45.5x45x20.3mm

Compatible Load Types

Load Symbol	Load Type	Maximum Load	Remarks
	LED lamps with transformers	390W/CH @ 230V 180W/CH @ 110V	Due to variety of LED lamp designs, maximum number of LED lamps is further dependent on power factor result when connected to switch.
	LED drivers	390W/CH @ 230V 180W/CH @ 110V	Maximum permitted number of drivers is 390W divided by driver nameplate power rating.
	Incandescent lighting, HV Halogen lamps	1170W/CH @ 230V 560W/CH @ 110V	
	Low voltage halogen lighting with electronic transformers	390W/CH @ 230V 180W/CH @ 110V	

Over Current Protection

- When connecting resistive load and total load is over 8.1A, the relay will be forced to off and protected.

- 2-gang ZigBee in-wall switch based on latest ZigBee 3.0 protocol
- 100-240VAC wide input and output voltage
- Supports resistive loads and capacitive loads
- 2 channels output, max. load 5.1A/CH
- Input and output with screw terminals, safe and reliable
- Enables to control ON/OFF of connected load
- ZigBee device with 2 endpoints which can be controlled separately
- ZigBee end device that supports Touchlink commissioning
- Can directly pair to a compatible ZigBee remote via Touchlink without coordinator
- Supports self-forming zigbee network without coordinator and add other devices to the network
- Supports find and bind mode to bind a ZigBee remote
- Supports zigbee green power and can bind max. 20 zigbee green power switches
- Compatible with universal ZigBee gateway products
- Can be controlled by universal single wire push switch, 2 channels can be controlled separately by 2 switches
- Active power and energy metering functionality
- Mini Size, Easy to be installed into a standard wall box
- Radio Frequency : 2.4GHz
- Waterproof grade: IP20

Safety & Warnings

- DO NOT install with power applied to device.
- DO NOT expose the device to moisture.

ZigBee Clusters the device supports are as follows:

Input Clusters

- 0x0000: Basic
- 0x0003: Identify
- 0x0004: Groups
- 0x0005: Scenes
- 0x0006: On/off
- 0x0702: Simple Metering
- 0x0b04: Electrical Measurement
- 0x0b05: Diagnostics

Output Clusters

- 0x0019: OTA

Operation

1. Do wiring according to connection diagram correctly.

2. This ZigBee device is a wireless receiver that communicates with a variety of ZigBee compatible systems. This receiver receives and is controlled by wireless radio signals from the compatible ZigBee system.

3. ZigBee Network Pairing through Coordinator or Hub (Added to a ZigBee Network)

Step 1: Remove the device from previous zigbee network if it has already been added to, otherwise pairing will fail. Please refer to the part "Factory Reset Manually".

Step 2: From your ZigBee Controller or hub interface, choose to add lighting device and enter Pairing mode as instructed by the controller.

Step 4: Connected light will blink 5 times and then stay solid on, then the device will appear in your controller's menu and can be controlled through controller or hub interface.

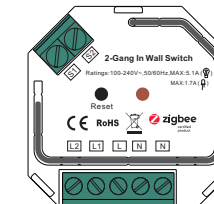

Step 3: Reset power of the device to set it into network pairing mode (connected light flashes twice slowly), 15 seconds timeout, repeat this step.

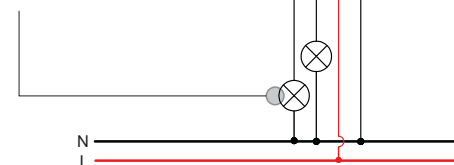

4. TouchLink to a Zigbee Remote

Step 2: Bring the remote or touch panel within 10cm of the lighting device.

Step 3: Set the remote or touch panel into Touchlink commissioning, please refer to corresponding remote or touch panel manual to learn how.

Step 4: There shall be indication on the remote for successful link and connected light will flash twice.

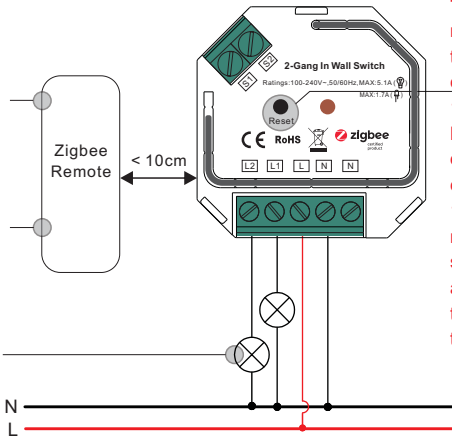

Step 1: Method 1: Short press "Reset" button 4 times (or reset power of the device 4 times) to start Touchlink commissioning immediately, 180S timeout, repeat this step.
Method 2: Reset power of the device, Touchlink commissioning will start after 15S if it's not added to a zigbee network, 165S timeout. Or start immediately if it's already added to a network, 180S timeout. Once timeout, repeat this step.

- Note:**
- 1) Directly TouchLink (both not added to a ZigBee network), each device can link with 1 remote.
 - 2) TouchLink after both added to a ZigBee network, each device can link with max. 30 remotes.
 - 3) To control by both gateway & remote, add remote and device to network first then TouchLink.
 - 4) After TouchLink, the device can be controlled by the linked remotes.

5. Removed from a Zigbee Network through Coordinator or Hub Interface

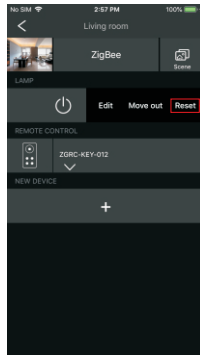

From your ZigBee controller or hub interface, choose to delete or reset the lighting device as instructed. The connected light blinks 3 times to indicate successful reset.

6. Factory Reset Manually

Note: 1) If the device is already at factory default setting, there is no indication when factory reset again.

2) All configuration parameters will be reset after the device is reset or removed from the network.

Step 2: Connected light will blink 3 times to indicate successful reset.

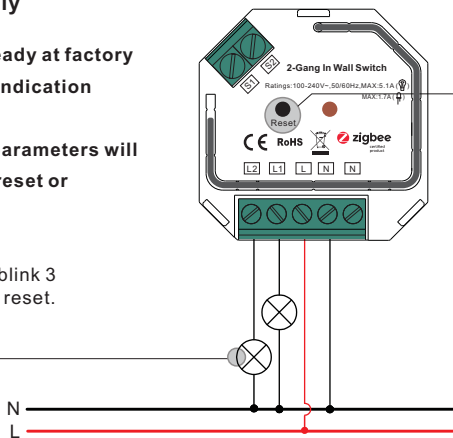

Step 1: Short press "Reset." key for 5 times continuously or reset power of the device for 5 times continuously if the "Reset" key is not accessible.

7. Factory Reset through a Zigbee Remote (Touch Reset)

Note: Make sure the device already added to a network, the remote added to the same one or not added to any network.

Step 2: Bring the remote or touch panel within 10cm of the lighting device.

Step 3: Set the remote or touch panel into Touch Reset procedure to reset the device, please refer to corresponding remote or touch panel manual to learn how.

Step 4: There shall be indication on the remote and connected light flashes 3 times for successful reset.

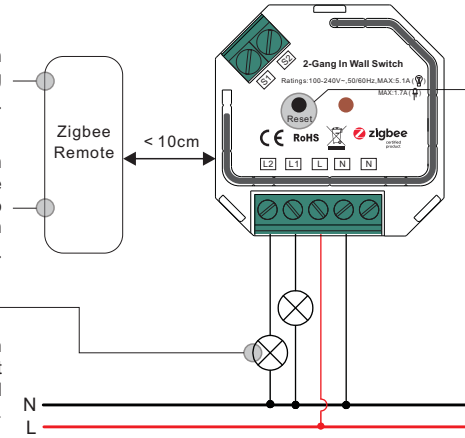

Step 1: Short press reset button 4 times to start TouchLink Commissioning, 180 seconds timeout, repeat this step.

8. Find and Bind Mode

Note: Make sure the device and remote already added to the same zigbee network.

Step 2: Set the remote or touch panel (target node) into find and bind mode, and enable it to find and bind initiator, please refer to corresponding remote or touch panel manual.

Step 3: There shall be indication on the remote or touch panel that it bind the device successfully and can control it then. to learn how.

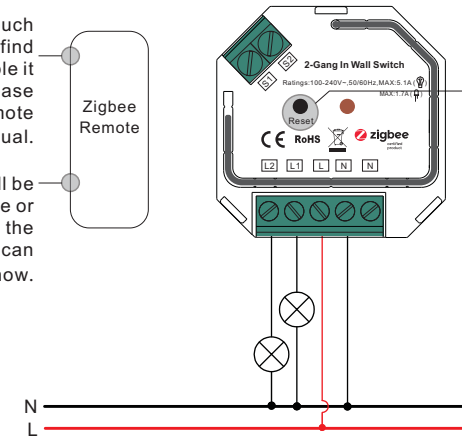

Step 1: Short press "Reset." button 3 times (Or reset power of the device (initiator node) 3 times) to start Find and Bind mode (connected light flashes slowly) to find and bind target node, 180 seconds timeout, repeat this step.

9. Learning to a Zigbee Green Power Switch

Step 2: Set the green power switch into Learning mode, please refer to its manual.

Step 3: Connected light will flash twice to indicate successful learning. Then the switch can control the device.

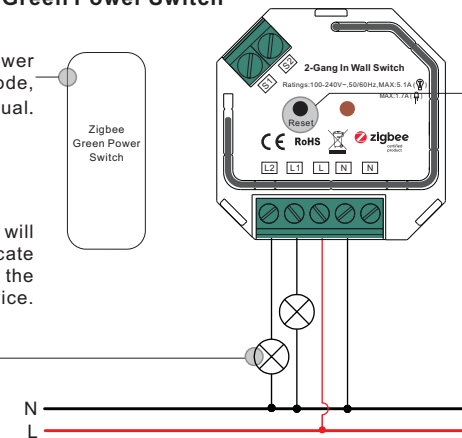

Step 1: Short press "Reset." button 4 times (Or reset power of the device 4 times) to start Learning to GP switch mode (connected light flashes twice), 180 seconds timeout, repeat this step.

Note: Each device can learn to max. 20 zigbee green power switches.

10. Delete Learning to a Zigbee Green Power Switch

Step 2: Set the paired green power switch into Learning mode, please refer to its manual.

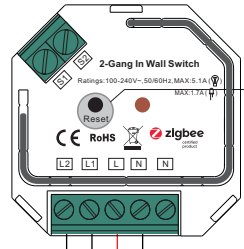

Step 1: Short press "Reset." button 3 times (Or reset power of the device 3 times) to start delete Learning to GP switch mode (connected light flashes slowly), 180 seconds timeout, repeat this step.

Step 3: Connected light will flash 4 times to indicate successful deleting.

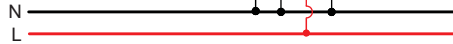

11. Setup a Zigbee Network & Add Other Devices to the Network (No Coordinator Required)

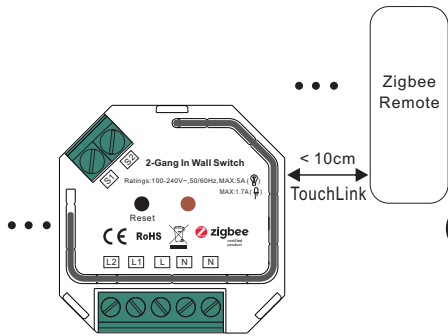

< 10cm
TouchLink

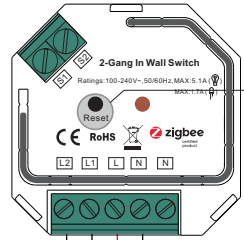

Step 1: Short press "Reset." button 4 times (Or reset power of the device 4 times) to enable the device to setup a zigbee network (connected light flashes twice) to discover and add other devices, 180 seconds timeout, repeat this step.

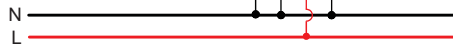

Step 2: Set another device or remote or touch panel into network pairing mode and pair to the network, refer to their manuals.

Step 3: Pair more devices and remotes to the network as you would like, refer to their manuals.

Step 4: Bind the added devices and remotes through Touchlink so that the devices can be controlled by the remotes, refer to their manuals.

Note: 1) Each added device can link and be controlled by max. 30 added remotes.

2) Each added remote can link and control max. 30 added devices.

12. OTA

The device supports firmware updating through OTA, and will acquire new firmware from zigbee controller or hub every 10 minutes automatically.

Wiring Diagram

Notes for the diagrams:

L - terminal for live lead

N - terminal for neutral lead

S1 - terminal for switch key No. 1

S2 - terminal for switch key No. 2

L1 - output terminal no. 1 for light load

L2 - output terminal no. 2 for light load

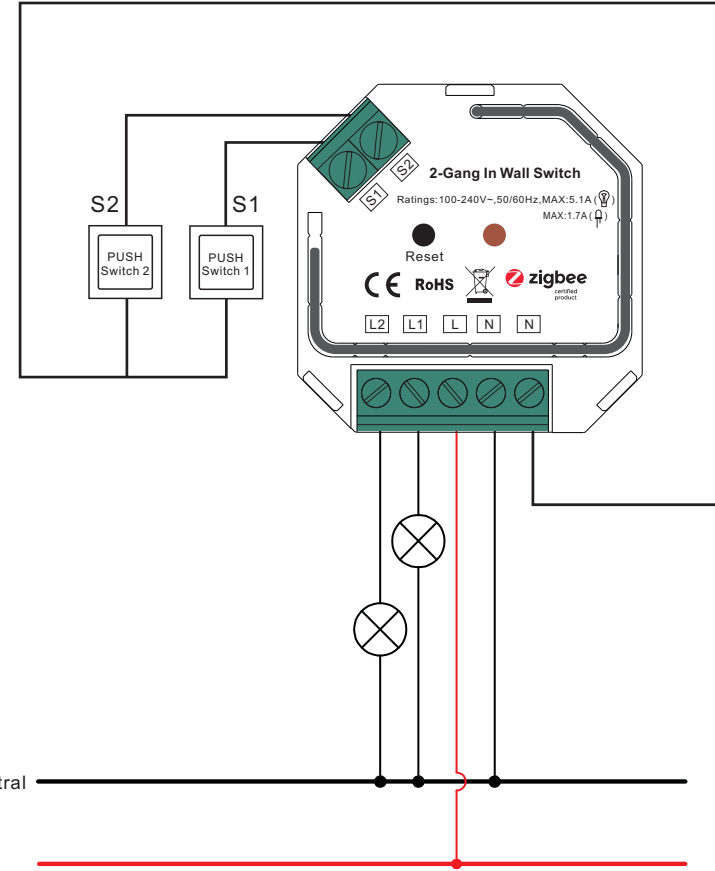

Product Dimension

