

Specification

Prepared	Checked	Approved	Accepted	Confirmed	Approved

UL

CE

RoHS

2835
SMD

336
LEDS/M

LED
Strip

DC
24V

IP
65

3
years

Model: ☉RX2K01TC -9XX-P21 RX2K01TC -9XX-P22

5000*D23mm, 1680Leds, SMD2835 360° luminous neon light,
Horizontal outlet (15W/m)

5000*D23mm, 1680Leds, SMD2835 360° luminous neon light,
Side outlet (15W/m)

Picture:

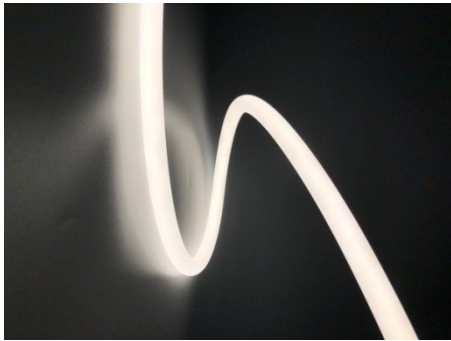

Features:

- ☉ Full version 360° round light surface, uniform light, no dark place, no light spot;
- ☉ Surface anti-static treatment, good weather resistance, soft hand feeling;
- ☉ Can be cut in any size without damaging the light, application is more convenient;
- ☉ IP65 protection performance;
- ☉ Salt resistance, acid and alkali resistance, corrosion resistance, flame retardant resistance, UV resistance;
- ☉ Various installation methods, Free and unlimited DIY application scenarios;
- ☉ UL、CE、RoHS compliant, guaranteed quality.

Applications:

- ☉ Application: Office lighting、Decorative lighting、Artistic lighting、Styling lighting etc.

Warranty:

- ☉ 3 years or 13,000 hours, whichever comes first

Optical and Electrical Parameters:

P/N	LED Color	CCT (K) WL	CRI	SDCM	Beam Angle (°)	Lumino us Flux (lm/m)	Luminou s Efficacy (lm/w)	Working voltage (VDC)	Working current(mA)		Power (w)	
									1m[3 9.37 in]	5m[1 96.8 5in]	1m[3 9.37 in]	5m[1 96.8 5in]
RX2K01TC-923-P21	W	2300K	RA90	/	360	750	50	24	600	2500	14.4	60
RX2K01TC-927-P21	W	2700K	RA90	/	360	950	65	24	600	2500	14.4	60
RX2K01TC-930-P21	W	3000K	RA90	/	360	950	65	24	600	2500	14.4	60
RX2K01TC-940-P21	W	4000K	RA90	/	360	950	65	24	600	2500	14.4	60
RX2K01TC-923-P22	W	2300K	RA90	/	360	750	50	24	600	2500	14.4	60
RX2K01TC-927-P22	W	2700K	RA90	/	360	950	65	24	600	2500	14.4	60
RX2K01TC-930-P22	W	3000K	RA90	/	360	950	65	24	600	2500	14.4	60
RX2K01TC-940-P22	W	4000K	RA90	/	360	950	65	24	600	2500	14.4	60

Others:

P/N	IP Grade	Operating Temp		Storage Temp		Standard length		Max. cascading length		LED Qty (pcs)	Weight	
		(°C)	(°F)	(°C)	(°F)	(m)	(inch)	(m)	(inch)		(g/m)	(lb/m)
RX2K01TC-9XX-P21	IP65	-30~50	-22~+122	0~+60	32~+140	5	196.85	5	196.85	336	520	1.15
RX2K01TC-9XX-P22	IP65	-30~50	-22~+122	0~+60	32~+140	5	196.85	5	196.85	336	520	1.15

Notes:

- (1) Testing environment temperature: 25±2°C [77±3.6°F];
- (2) The above data each single product could differ from the typical values. The data subject to change without prior notice;
- (3)The above "--" means the parameters are not required temporarily.

Profile Drawings:

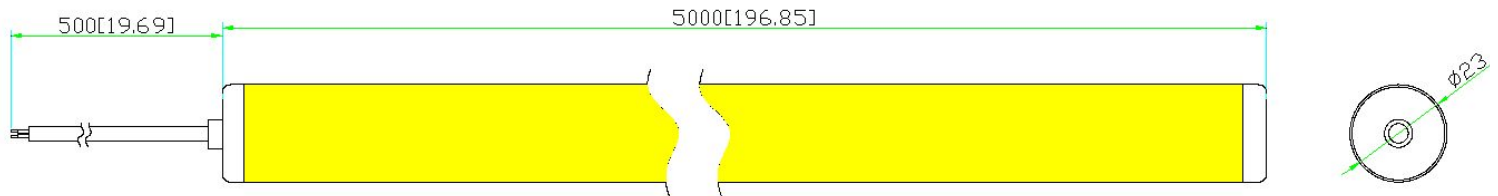

Unit: mm[inch]

RX22C0TC-A top outlet

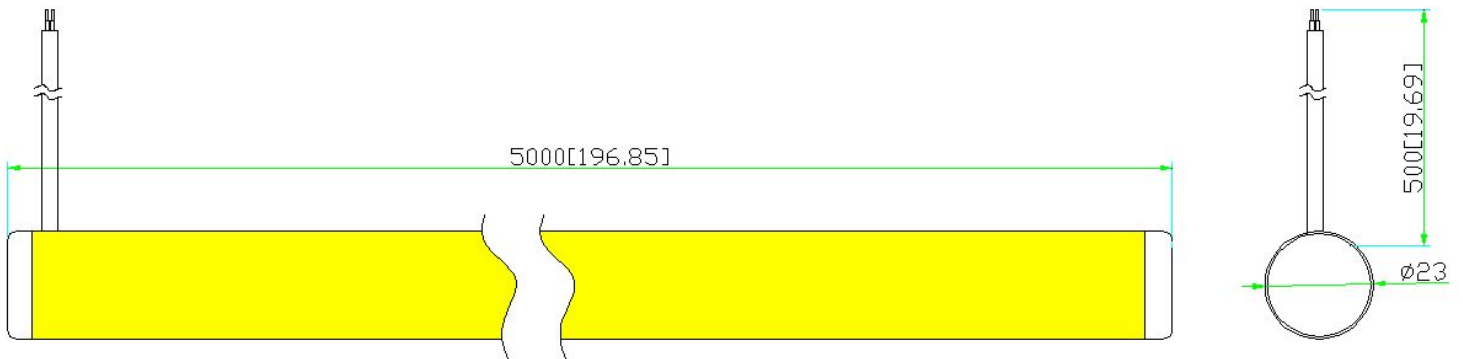

RX22C0TC-A side outlet

Light Distribution/Iso-illuminance Diagram:

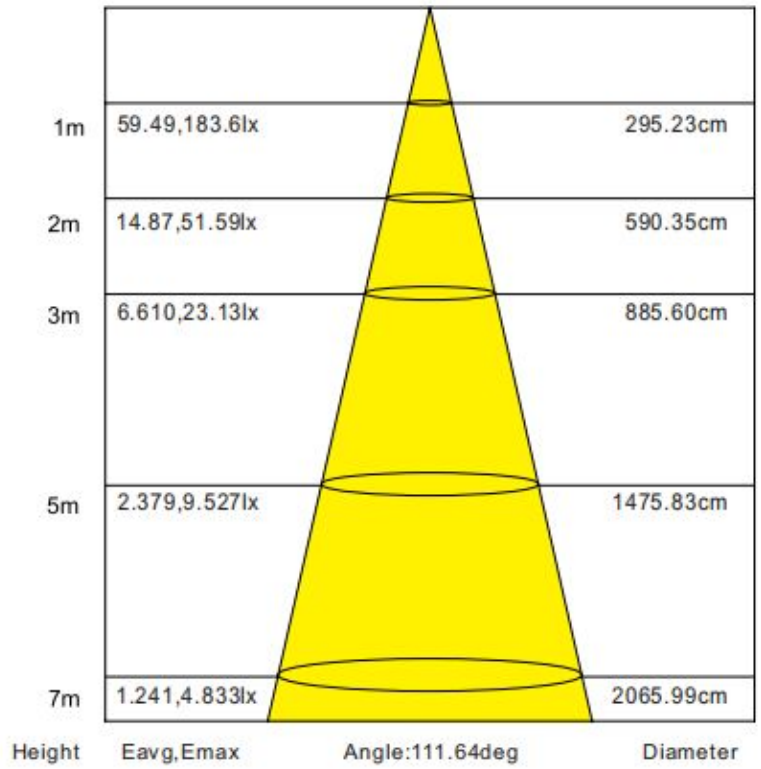
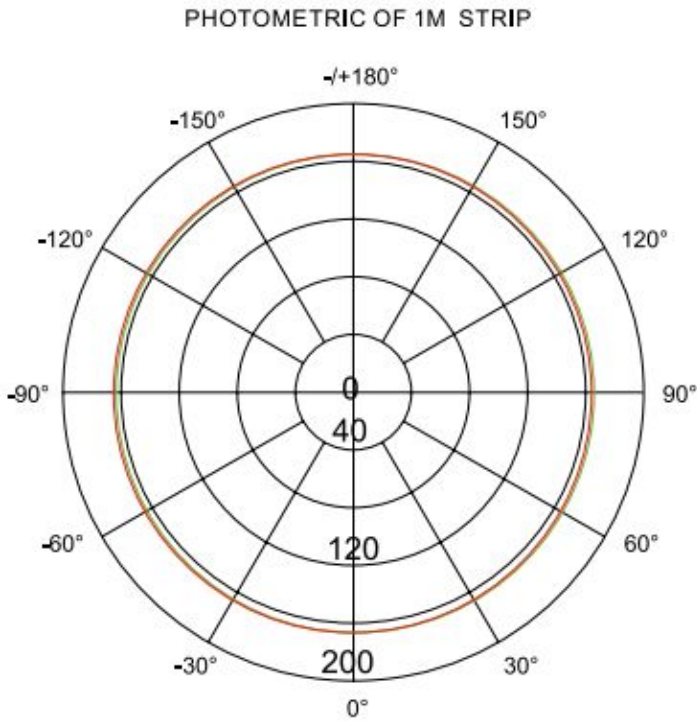

Packaging Information:

P/N	Qty (m/reel)	Qty (m/carton)	Total Qty (m)	Total weight		Outer carton size					
						length		width		height	
				(kg)	(lb)	(mm)	(inch)	(mm)	(inch)	(mm)	(inch)
RX2J01TC-9XX- P21	5	20	20	10.4	22.93	430	16.93	430	16.93	325	12.80
RX2J01TC-9XX- P22	5	20	20	10.4	22.93	430	16.93	430	16.93	325	12.80

Notes: Above qty and weight of packing is only for the packing shown in the picture, which might be different from other packing modes, thus for actual qty and weight please refer to actual samples.

Packaging Diagram :

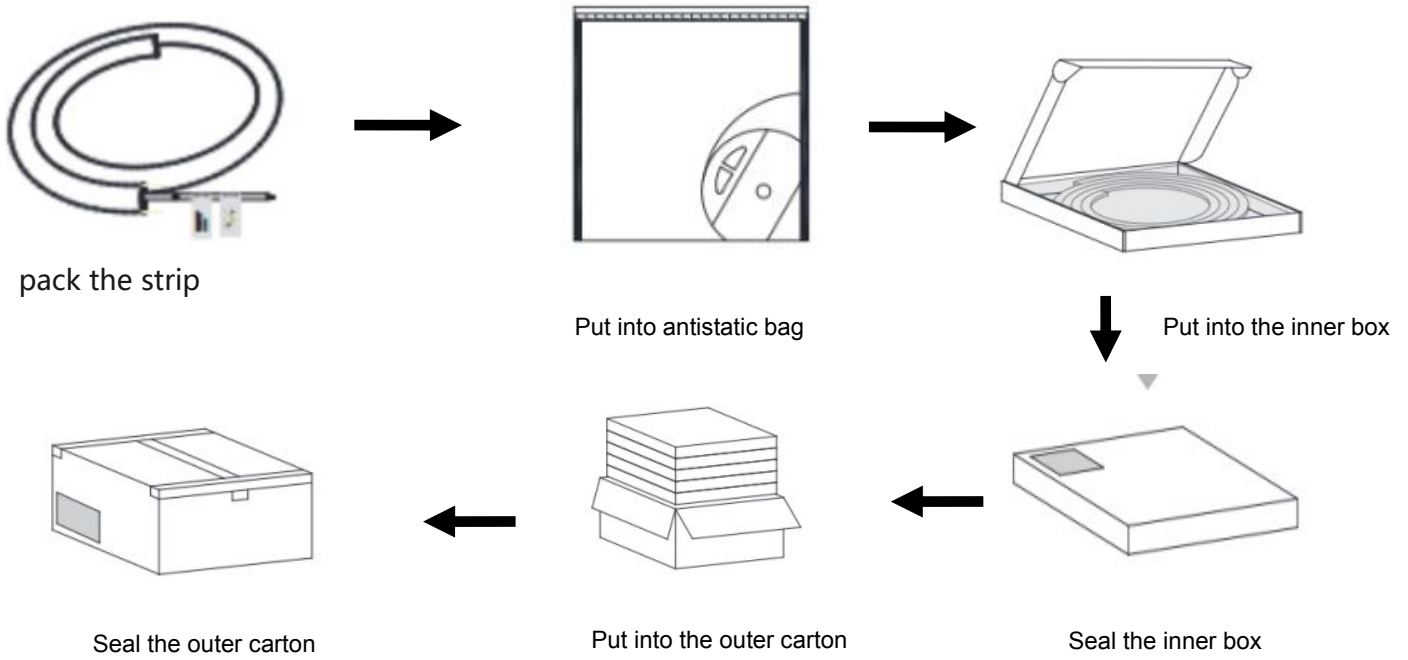



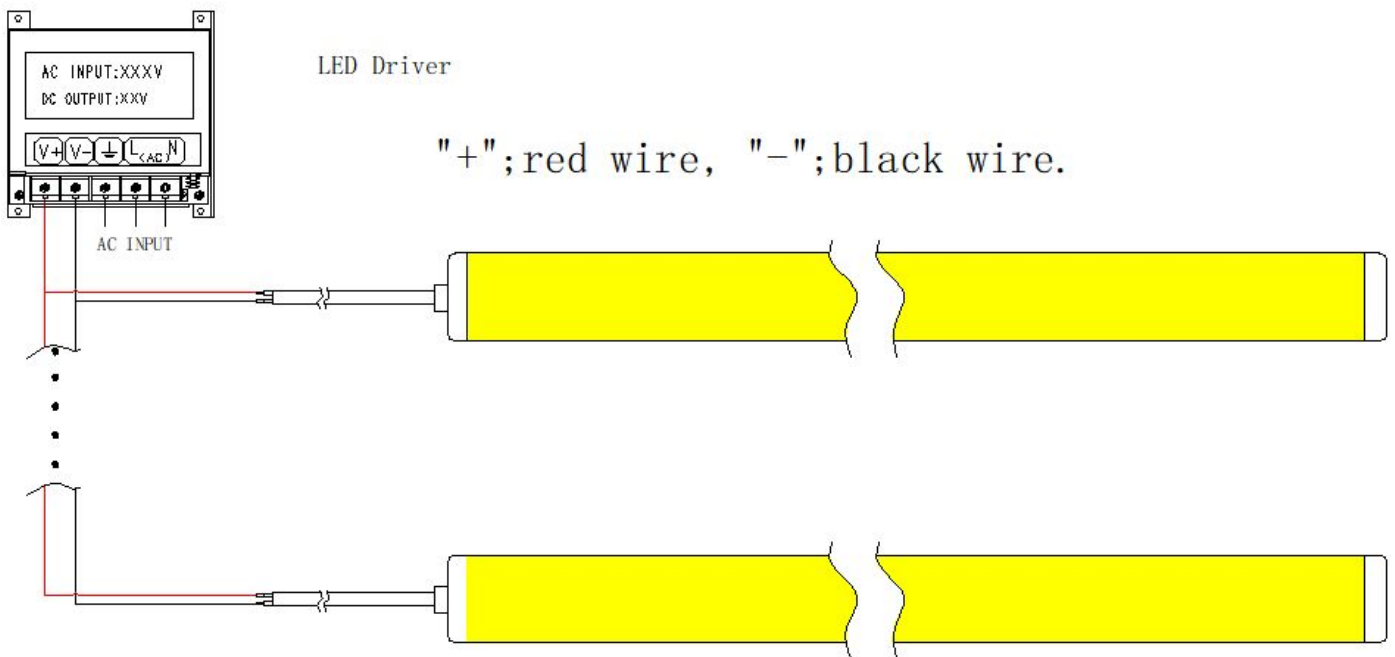

Connection Instruction :



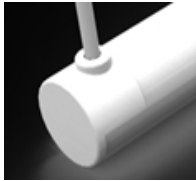

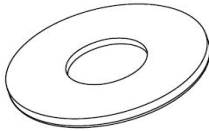



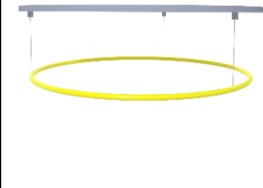

Notes: please make sure the "+" and "-" of the product's input are correctly connected to those of the power supply

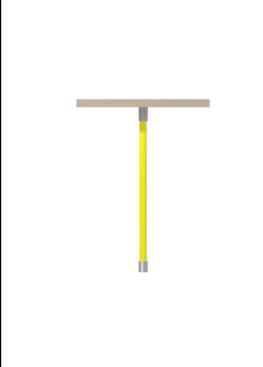
Optional accessories:

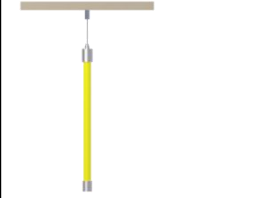
Product code	describe	Schematic picture	remarks
611-015	D23 Side outlet cap		Side outlet cap*1
611-016	D23 Horizontal outlet cap		Horizontal outlet cap*1
611-017	D23 Silicone end cap		Silicone end cap*1
611-018	PC transparent clip		clip*1 Screw*2
611-019	PC Transparent Installation cover		cover*1 Screw*8

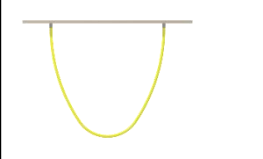
Install accessory kit:

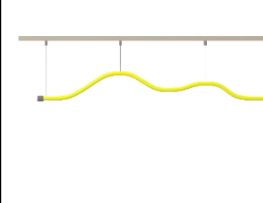
Product code	describe	Schematic picture	Application scenario diagram	remarks
611-027	Splicing kit (1~5M)			Complete use
611-033	Vertical ceiling installation (1M or 2.5M)			Complete use
611-034	Vertical suspension installation (1M or 2.5M)			Complete use
611-035	double-ended ceiling installation(1~5M)			Complete use
611-036	Moldable mounting accessories			Complete use

Troubleshooting:

Malfunctions	Possible Causes	Solutions
All LEDs don't work	1. The power supply did not connect to power grid.	Power on
	2. No electricity due to short-circuit of external power supply.	Remove the malfunction caused by short-circuit, power on again.
	3. The wires of strips connect to power supply output reversely.	Check the connecting and ensure the wires are connected correctly.
Part of LEDs don't work	1. Part of power supplies do not have output.	Check the power supply system.
	2. Part of wires of strips have malfunction.	
	3. Particular modules connected reversely.	Correct connection
Brightness of LEDs is weak or uneven	1. Overloaded power supply;	Replace it with higher power supply
	2. The power loss of power circuit is huge or the power loss of each circuit existing big difference.	Ensure working voltage of strips is within $\pm 5\%$ V of rated voltage. (1. Shorten the length of wires between the first strip and power supply or replaced with wires with bigger diameter; 2. Ensure the cascading qty of string is less than or equal to the allowed maximum cascading qty, and each strip cascading qty is well-balanced.)
	3. Exceed in qty of strips in series	Lessen the cascading qty for strip and ensure the qty for each electrical circuit is within the maximum cascading qty.
LEDs are blinking	1. Poor contacted in the joints.	Find out and tackle malfunction immediately.
	2. Failures in power supply.	Replace power supply.

Declaration:

- ⊙ If the external flexible cable of light box is damaged, please replace it by its manufacturer or its service agent or qualified person to avoid a hazard.
- ⊙ The specific installation and cautions please refer to the user manual.
- ⊙ The given data in this specification is based on our standard product. There may be existed slight difference compared with actual products.
- ⊙ All Illustrations in this specification are for reference only.
- ⊙ This product is subject to change or modify without prior notice.
- ⊙ RISHANG OPTOELECTRONICS CO., LTD. reserves the right of final explanation for this specification.

<End>

Rishang Optoelectronics Co., Ltd. (stock code: 002654)

Add: Block 2, Hongfa jiateli High-Tech. Park Tangtou Ave., Shiyan, Bao'an Shenzhen
Guang Dong, 518108, China
Tel: +86-755-33258896 E-mail: info@ledlamps.com.cn
Website: www.ledlamps.com.cn

Website

Official Account

