

# User Guide

## Wall Mounted Touch Panel Single Color / Dual Color / RGB / RGBW LED Constant Voltage Controller

Wall mounted single color/dual color/RGB/RGBW LED controller T1-1/T2-1/T3-1/T4-1 is a full touch controller with 4 channel constant voltage output, and offers fast and accurate color adjustment with unique design touch color slide.

### Feature

- Touch panel single color, dual color, RGB or RGBW PWM constant voltage controller.
- Ultra sensitive high strength glass touch panel with touch color slide in the middle and backlighting.
- Smooth and accurate color adjustment by touching the color slide.
- Adopt 2.4GHz wireless technology, remote distance up to 30m.
- Touch keys with chord tones and LED indicator.

### Technical parameter

Model	Input voltage	Output signal	Output current	Output power	Light type	Size(mm)
T1-1	12-24VDC	PWM	4CH,3A/CH	144-288W	Single color	86x86x35
T2-1	12-24VDC	PWM	4CH,3A/CH	144-288W	Dual color	86x86x35
T3-1	12-24VDC	PWM	3CH,4A/CH	144-288W	RGB	86x86x35
T4-1	12-24VDC	PWM	4CH,3A/CH	144-288W	RGBW	86x86x35

### Match guide

Panel controller can match with RF remote by using power-up optionally.

1. Match: Switch off the power, then switch on power again, short press on/off key or zone key 3 times on the RF remote quickly within 5s after power on, the link is done once the light blinks 3 times.
2. Delete: Switch off the power, then switch on power again, short press on/off key or zone key 5 times on the RF remote quickly within 5s after power on, the unlink is done once the light blinks 5 times.
3. Multiple zone remote only use zone key to match each zone receiver.

### Key function

#### • Single color panel

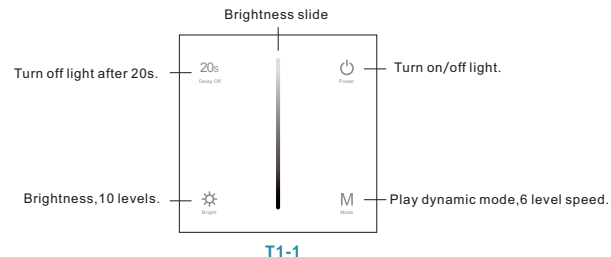

#### • Dual color panel

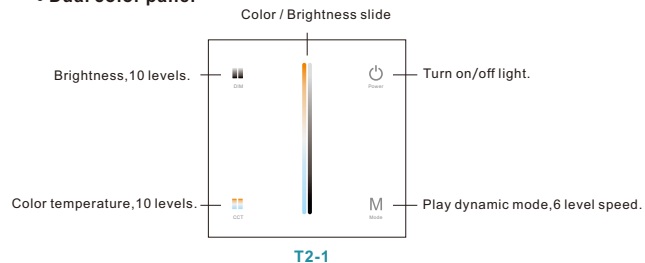

#### • RGB panel

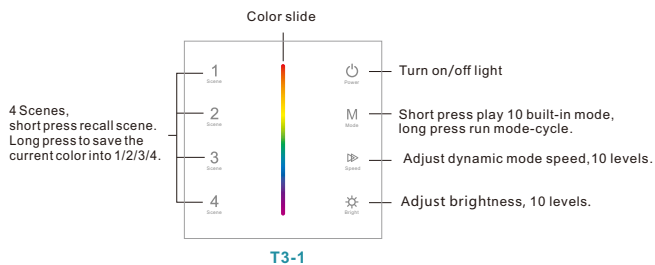

#### • RGBW panel

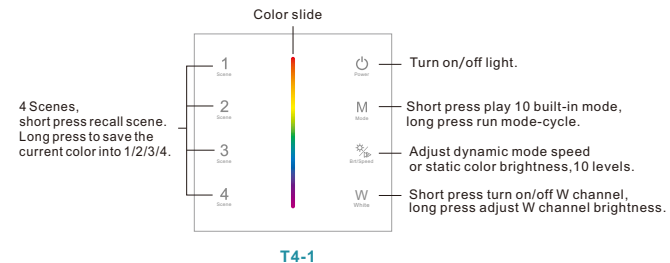

**Note:** After touch power key to turn off light, long press power key for 5 seconds will turn on or turn off tone.

### Wiring diagram for PWM output

#### • T1-1 Single color panel

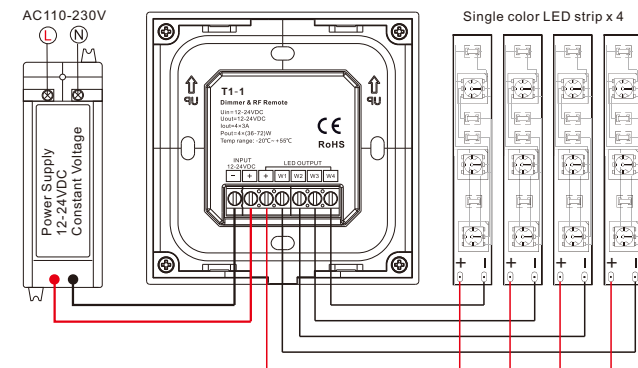

• T2-1 Dual color panel

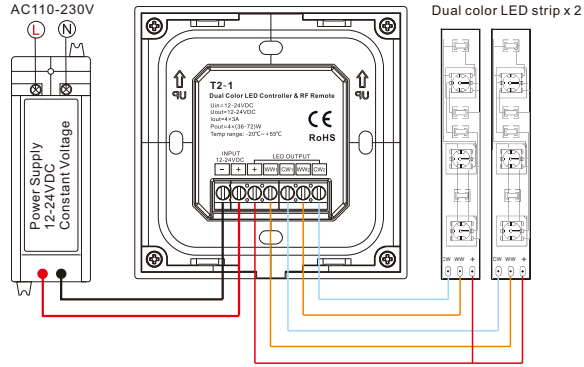

• T4-1 RGBW panel

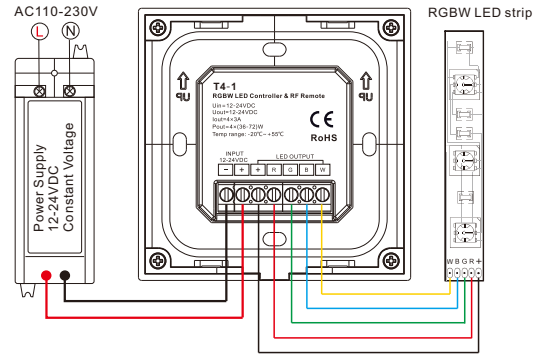

• T3-1 RGB panel

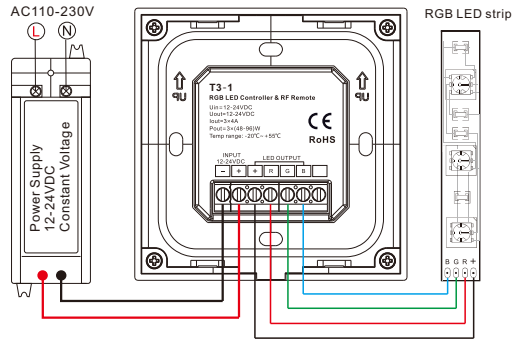

LED power supply voltage and power select :

- 12V lamp, Input 12V power supply, can load 0~144W,
  - 24V lamp, Input 24V power supply, can load 0~288W,
- The power supply power must larger than load power 20%.

Dimension

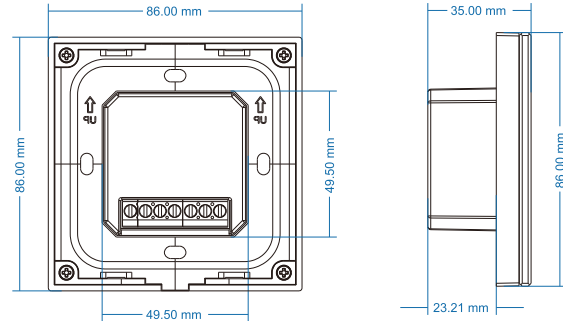

Installation diagram

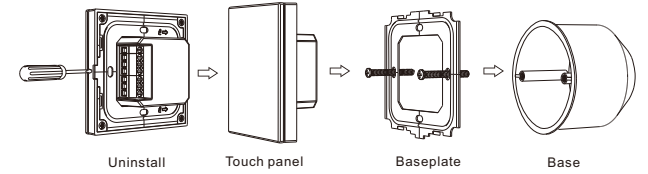

Typical base as below:

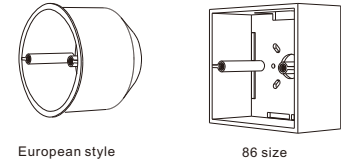

Malfunctions analysis & troubleshooting

Malfunctions	Causes	Troubleshooting
No light	1. No power. 2. Wrong connection or insecure.	1. Check the power. 2. Check the connection.
Wrong color	1. Wrong connection of R/G/B/W wires.	1. Reconnect R/G/B/W wires.
Uneven intensity between front and rear, with voltage drop	1. Output cable is too long. 2. Wire diameter is too small. 3. Overload beyond power supply capability. 4. Overload beyond controller capability.	1. Reduce cable or loop supply. 2. Change wider wire. 3. Replace higher power supply. 4. Add power repeater.

Safety information

1. The product shall be installed and serviced by a qualified person.
2. The product is non-waterproof. Please avoid the sun and rain.
3. Good heat dissipation will prolong the working life of the controller, Please ensure good ventilation.
4. Please check if the output voltage of any power supplies used comply with the working voltage of the product.
5. Ensure all wire connections and polarities are correct and secure before applying power to avoid any damages to the LED lights.
6. If a fault occurs please return the product to your supplier. Do not attempt to fix this product by yourself.