

Universal RF+Bluetooth LED Dimmer

SB.9001CS.04007



Important: Read All Instructions Prior to Installation

Function introduction

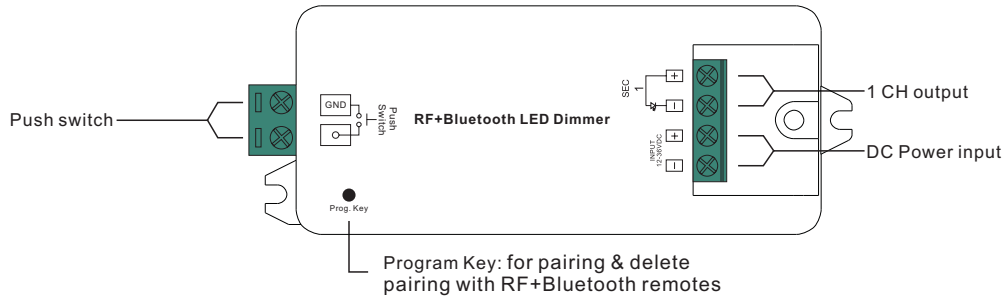

Product Data

No.	Input Voltage	Output Current	Output Power	Remarks	Size(LxWxH)
1	12-36VDC	1x8A	1x(96-288)W	Constant voltage	95x37x20mm
2	12-36VDC	1x350mA	1x(4.2-12.6)W	Constant current	95x37x20mm
3	12-36VDC	1x700mA	1x(8.4-25.2)W	Constant current	95x37x20mm

- Universal RF+Bluetooth LED dimmer, radio frequency: 2.4GHz
- Controlled through both smart App and remote controls, no gateway required
- Easy & quick pairing to the smart App by simply pushing the Prog. button
- Mesh network, much longer control distance, transmits received signal to neighbor devices
- Up to 30m transmission distance between every two neighbor devices
- Encrypted two-way communication, quick status feedback, safe & reliable data transmission
- Compatible with universal RF+Bluetooth remotes, each LED controller can pair to max. 8 remotes
- Cloud control is available for remote access, works with Amazon Alexa and Google Home
- Waterproof grade: Ip20

Safety & Warnings

- DO NOT install with power applied to device.
- DO NOT expose the device to moisture.

Operation

Pair/delete the pairing with RF+Bluetooth remote

1. Do wiring according to connection diagram.
2. Pair LED controller with RF+Bluetooth remote: please refer to the instruction of the remote that you would like to pair with.
3. Delete the pairing:
 - (1) Wire up the LED controller correctly, power on.
 - (2) Press and hold down the "Prog." button on the controller for over 3 seconds (or reset power of the device 8 times continuously if the button is not accessible to factory reset the device) until the connected light flashes, which means well deleted.

Note: factory resetting will restore all configured parameters of the device on the APP to factory default setting.

Pair with smart APP

1. Do wiring according to connection diagram.
2. Download EasyThings APP from IOS APP Store or Android Google Play to your smart phone or tablet by searching "EasyThings". (As shown in **Figure 1**)
3. Enable Bluetooth on your smart phone or tablet. (As shown in **Figure 2**)



Figure 1

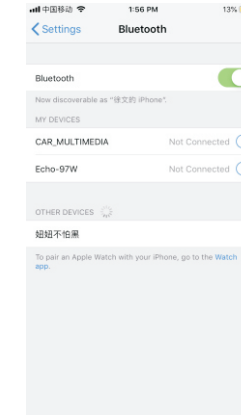

Figure 2

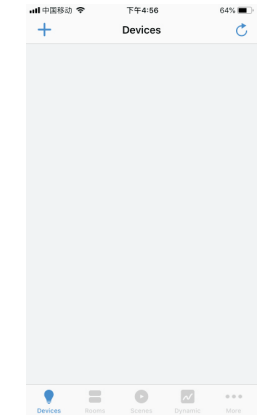

Figure 3

4. Run Easythings APP, tap add button " + " on the APP to add device, then choose "Discover devices" to discover device, then **short press the "Prog." button on the LED controller twice (or reset power of the controller twice continuously)** to set the device into pairing to APP mode. (As shown in **Figure 3 & Figure 4 & Figure 5**)

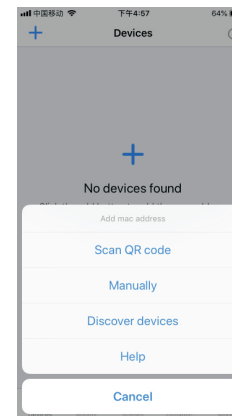

Figure 4

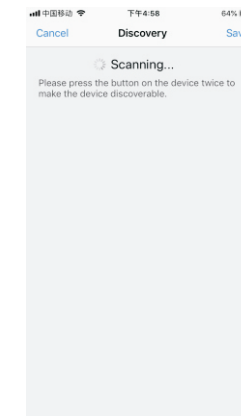

Figure 5

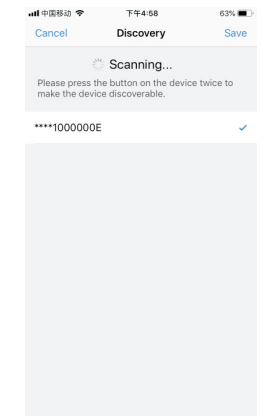

Figure 6

Note: multiple LED controllers can be discovered by the APP at the same time.

5. Once the device/device(s) are discovered, tick the device/device(s) and tap "Save" button, the device/device(s) will be added successfully. (as shown in **Figure 6**)

PUSH DIM:

While connected with PUSH LV, click the button to switch ON/OFF connected light. Press and hold down the button to increase/decrease light intensity between 1% and 100%.

Wiring Diagram

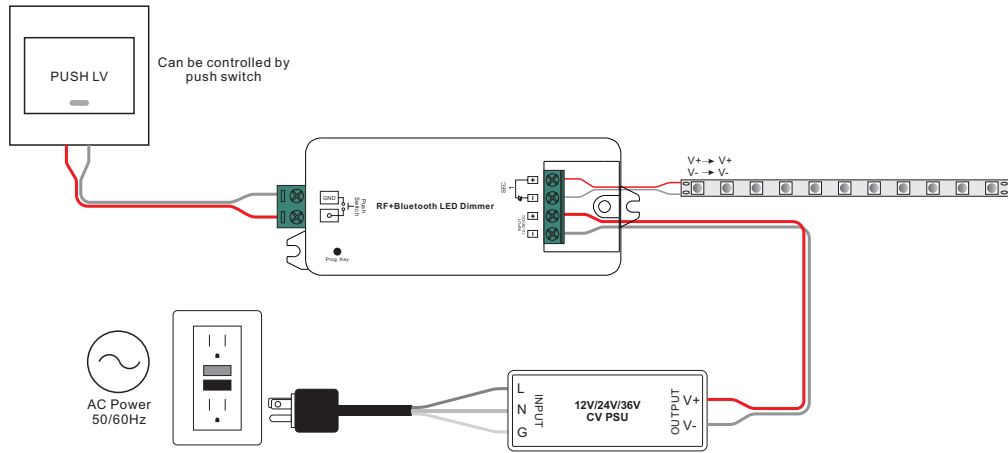

Product Dimension

