

Specification

Prepared	Checked	Approved	Accepted	Confirmed	Approved

UL	CE	RoHS	5050 SMD	30/60 LEDS/M	LED Strip	DC 12V/24V	IP 54	3 years
-----------	-----------	------	--------------------	------------------------	----------------------------	---------------	-----------------	-------------------

Model: ◎ RD6030AQ、RD6030AP、RD6060AQ、RD6060AP、RD6260AC-A、RD6260AC-C

5000*10mm, 150pcs 5050 SMD LED, silica gel injectedseries, seven colours, 12V DC, LED flexible strip
 5000*10mm, 150pcs 5050 SMD LED, silica gel injectedseries, seven colours, 24V DC, LED flexible strip
 5000*10mm, 300pcs 5050 SMD LED, silica gel injectedseries, seven colours, 12V DC, LED flexible strip
 5000*10mm, 300pcs 5050 SMD LED, silica gel injectedseries, seven colours, 24V DC, LED flexible strip
 5000*12mm, 300pcs 5050 SMD LED, silica gel injectedseries, 24Vdc, constant voltage, RGBW colorful LED flex strip
 5000*12mm, 300pcs 5050 SMD LED, silica gel injectedseries, 24Vdc, constant voltage, RGBWW colorful LED flex strip

Features:

- ◎ New ID design, simple and elegant, highly textured;
- ◎ Integrated 5050 SMD LED, good light-mixing effect;
- ◎ Double-sided pure copper PCB, low attenuation;
- ◎ Anti-oxidation by silver;
- ◎ CE, RoHS, UL compliant, guaranteeing reliable quality.

Applications:

- ◎ Suitable for hotel, shopping mall, home, cabinet, show frame, etc. as main lighting, indirect lighting, cove lighting, contour lighting, decorative lighting, etc.

Figure:



Warranty:

- ◎ 3 years or 13,000 hours, whichever comes first.

Optical and Electrical Parameters:

P/N	LED Color	CCT (K) WL (nm)	CRI	SD CM	Beam Angle (°)	Luminous Flux (lm/m)	Luminous Efficacy (lm/W)	Working voltage (VDC)	Working current(mA)		Power(w)	
									1m[39 .37in]	5m[19 6.8in]	1m[39 .37in]	5m[19 6.8in]
									RD6030AQ	Red	620-625	--
	Green	525-530	--	--	≥115	175	81	12	180	720	2.16	8.6
	Blue	465-470	--	--	≥115	44	20	12	180	720	2.16	8.6
RD6030AP	Red	620-625	--	--	≥115	72	25	24	100	400	2.4	9.6
	Green	525-530	--	--	≥115	194	81	24	100	400	2.4	9.6
	Blue	465-470	--	--	≥115	49	20	24	100	400	2.4	9.6
RD6060AQ	Red	620-625	--	--	≥115	130	30	12	360	1430	4.3	17.2
	Green	525-530	--	--	≥115	355	83	12	360	1430	4.3	17.2
	Blue	465-470	--	--	≥115	94	22	12	360	1430	4.3	17.2
RD6060AP	Red	620-625	--	--	≥115	130	30	24	180	770	4.3	18.5
	Green	525-530	--	--	≥115	355	83	24	180	770	4.3	18.5

	Blue	465-470	--	--		94	22		180	770	4.3	18.5
	Red	620-625	--	--		128	30		180	770	4.3	18.5
	Green	525-530	--	--	≥115	299	70		180	770	4.3	18.5
RD6260AC-A	Blue	465-470	--	--		71	17	24	180	770	4.3	18.5
	white	2700	≥80	--	≥115	397	83		200	917	4.8	22
	Red	620-625	--	--		133	31		180	770	4.3	18.5
	Green	525-530	--	--	≥115	305	71		180	770	4.3	18.5
RD6260AC-A	Blue	465-470	--	--		74	17	24	180	770	4.3	18.5
	white	3000	≥80	--	≥115	411	86		200	917	4.8	22
	Red	620-625	--	--		137	32		180	770	4.3	18.5
	Green	525-530	--	--	≥115	314	73		180	770	4.3	18.5
RD6260AC-A	Blue	465-470	--	--		73	17	24	180	770	4.3	18.5
	white	4000	≥80	--	≥115	391	81		200	917	4.8	22
	Red	620-625	--	--		128	30		180	770	4.3	18.5
	Green	525-530	--	--	≥115	309	72		180	770	4.3	18.5
RD6260AC-A	Blue	465-470	--	--		73	17	24	180	770	4.3	18.5
	white	5000	≥80	--	≥115	395	82		200	917	4.8	22
	Red	620-625	--	--		130	30		180	770	4.3	18.5
	Green	525-530	--	--	≥115	314	73		180	770	4.3	18.5
RD6260AC-A	Blue	465-470	--	--		71	17	24	180	770	4.3	18.5
	white	6500	≥80	--	≥115	376	78		200	917	4.8	22
	Red	620-625	--	--		129	30		180	770	4.3	18.5
	Green	525-530	--	--	≥115	310	72		180	770	4.3	18.5
RD6260AC-C	Blue	465-470	--	--		73	17	24	180	770	4.3	18.5
	white	2400	≥80	--	≥115	390	81		200	917	4.8	22
	white	6500	≥80	--	≥115	442	92		200	917	4.8	22

Others:

P/N	IP Grade	Operating Temp		Storage Temp		Standard length		Max. cascading length		LED Qty (pcs)	Weight	
		(°C)	(°F)	(°C)	(°F)	m	inch	m	inch		(g/piece)	(lb/piece)
RD6030AQ	IP54	-25~	-13~	-25~	-13~	5	196.8	5	196.8	30	/	/

		+60	+140	+70	+158							
RD6030AP	IP54	-25~	-13~	-25~	-13~	5	196.8	5	196.8	30	/	/
		+60	+140	+70	+158							
RD6060AQ	IP54	-25~	-13~	-25~	-13~	5	196.8	5	196.8	60	/	/
		+60	+140	+70	+158							
RD6060AP	IP54	-25~	-13~	-25~	-13~	5	196.8	5	196.8	60	/	/
		+60	+140	+70	+158							
RD6260AC-A	IP54	-25~	-13~	-25~	-13~	5	196.8	5	196.8	60	/	/
		+60	+140	+70	+158							
RD6260AC-C	IP54	-25~	-13~	-25~	-13~	5	196.8	5	196.8	60	/	/
		+60	+140	+70	+158							

Notes:

- (1) Testing environment temperature: 25±2°C [77±3.6°F];
- (2) The actual data of each single product may differ from above typical data which are subject to change without prior notice;
- (3) The above "--" means the parameters are not required temporarily;
- (4) The product is controlled by controller, and the white light doesn't illuminate simultaneously with other three colors; the max power is 8.6W/m.

Profile Drawings:

Unit: mm [inch]

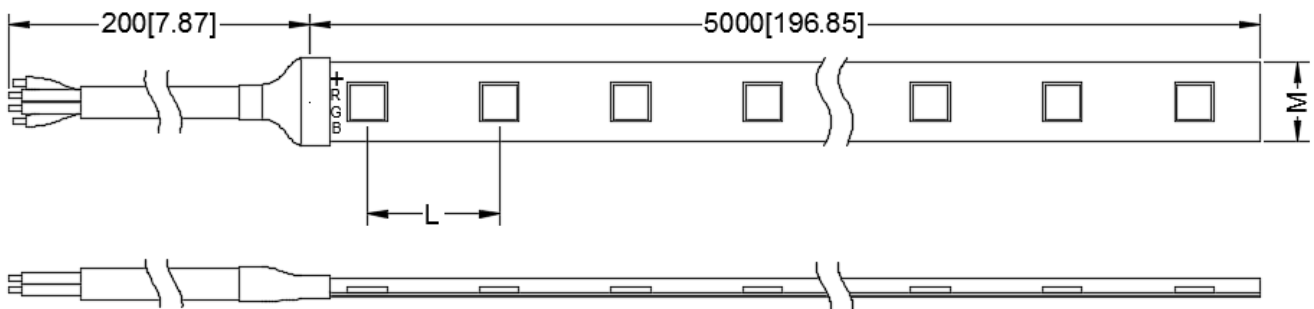

P/N	L	M
RD6030AQ	33.33[1.31]	10[0.39]
RD6060AQ	16.67[0.66]	10[0.39]
RD6060AP	16.67[0.66]	10[0.39]

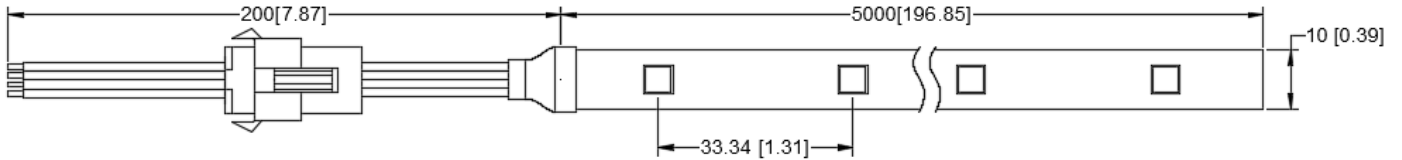

RD6030AP

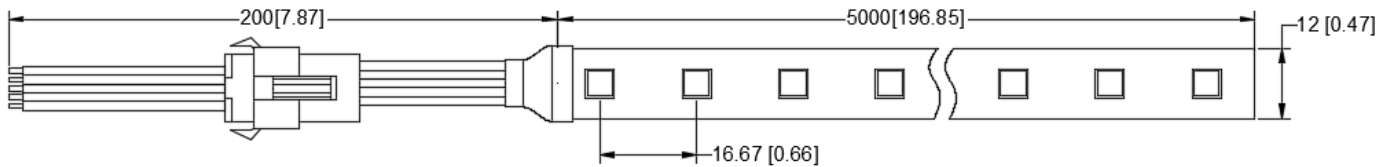

RD6260AC-A

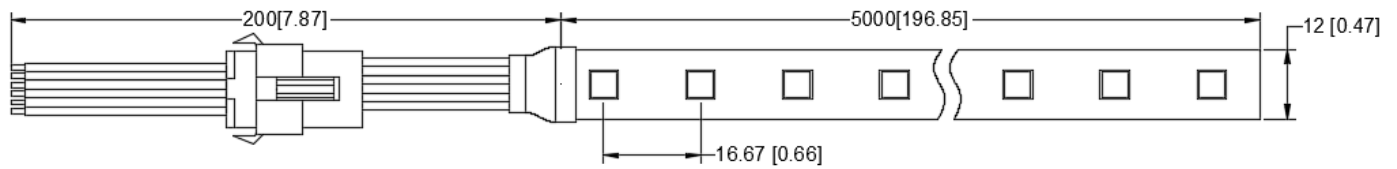

RD6260AC-C

Packaging Information:

P/N	Qty (PCS/m)	Qty (bag/carton)	Total Qty (PCS)	Total weight		Outer carton size					
				(Kg)	(lb)	length		width		height	
						(mm)	(inch)	(mm)	(inch)	(mm)	(inch)
RD6030AQ	5	75	150	6.5	14.3	458	18.03	256	10.07	268	10.55
RD6030AP	5	75	150	6.5	14.3	458	18.03	256	10.07	268	10.55
RD6060AQ	5	75	150	6.6	14.52	458	18.03	256	10.07	268	10.55
RD6060AP	5	75	150	6.6	14.52	458	18.03	256	10.07	268	10.55
RD6260AC-A	5	75	150	7.1	15.62	458	18.03	256	10.07	268	10.55
RD6260AC-C	5	75	150	7.1	15.62	458	18.03	256	10.07	268	10.55

Notes: Above qty and weight of packing is only for the packing shown in the picture, which might be different from other packing modes, thus for actual qty and weight please refer to actual samples.

Packaging Diagram:

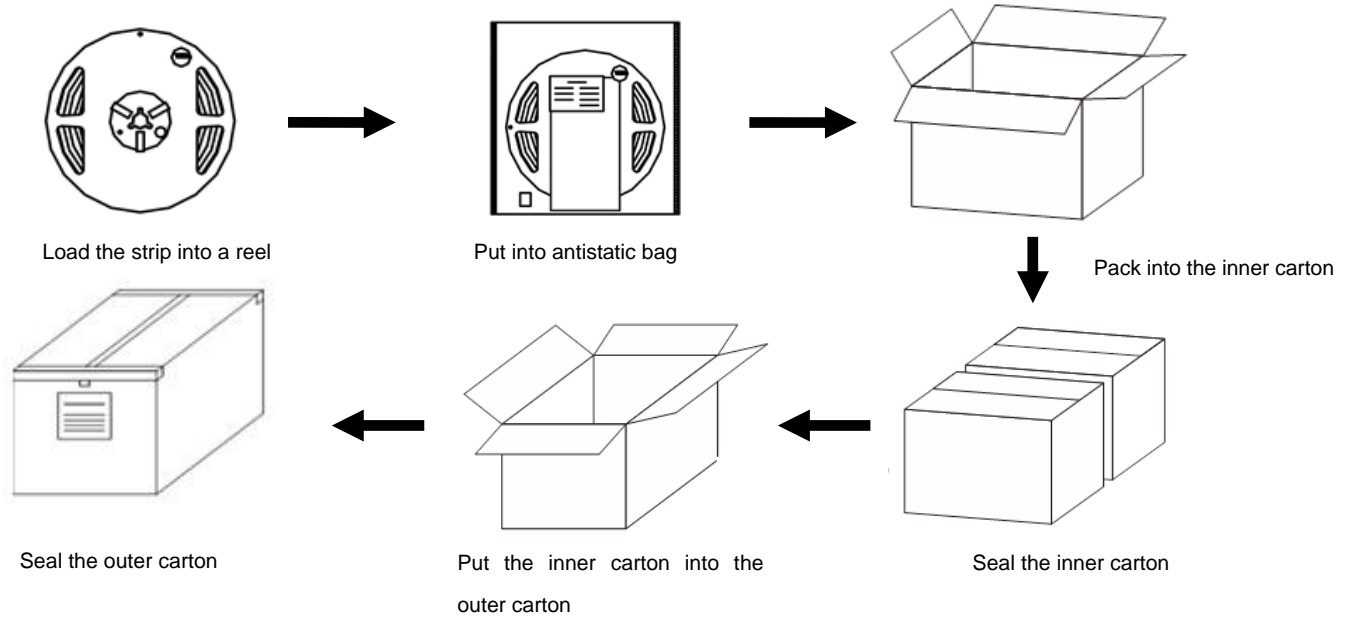

Connection Instruction:

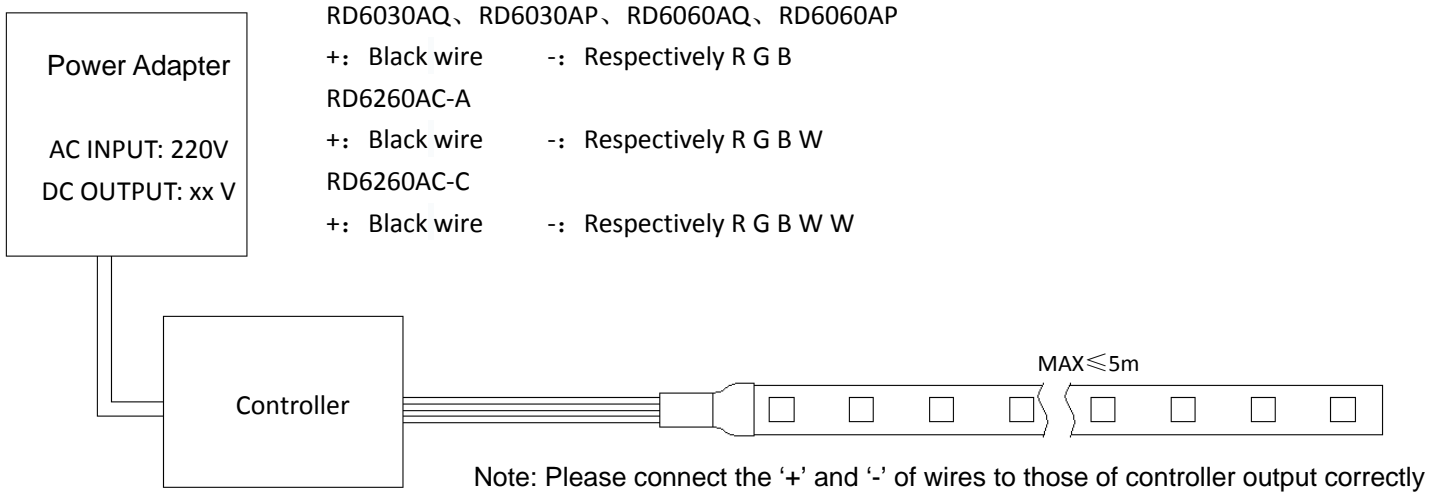

Parts & Tools:

◎ **Product Spare Parts**



LED Strip

◎ **Self-provided Tools**



Electrical Drill & Drilling bit

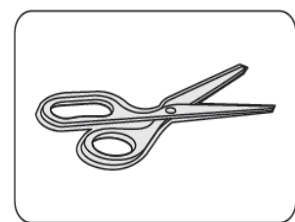

Scissors

Installation Steps & Cautions:

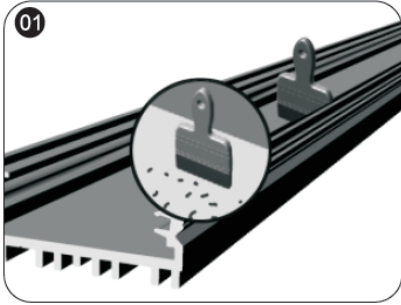

01 Make sure the mounting surface is clean before installation;

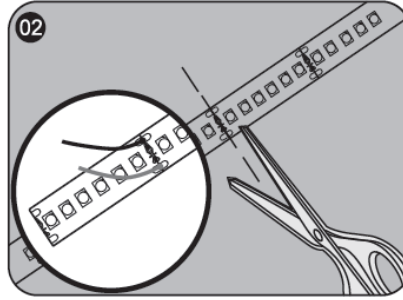

02 Calculate the needed length and cut off the extra length along cutting mark if necessary; if need to add wires, please weld them at the next location with printed mark.

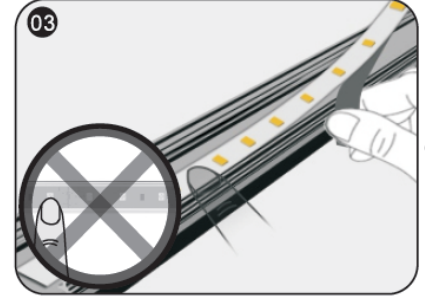

03 While sticking strips, peel off the release paper of the tape step by step. Don't peel off all release paper at a time to avoid getting your strip in a mess.
△Notes: No pressing the bead!



04 Stick Mylar tape to isolate the cutting position from the bottom of profile inner slot to avoid short-circuit;

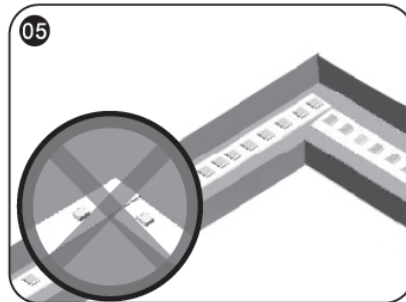

05 The installation at the corner is shown as the above figure.
△Notes: No bending it into right angle; No twisting it to stick on the mounting surface.



06 Connect strip wires to the output terminal of controller, and connect controller to the power supply, and dispose with waterproof, insulation, short-circuit and anti-corrosion protection at both the wire joints and the cut section of your strip (if any)

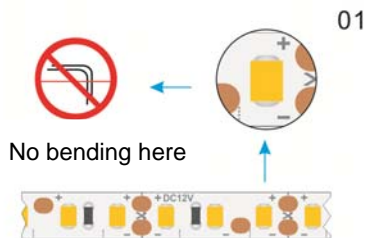

01 No bending the strip at the position of LED

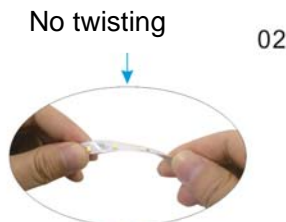

02 No twisting the strip

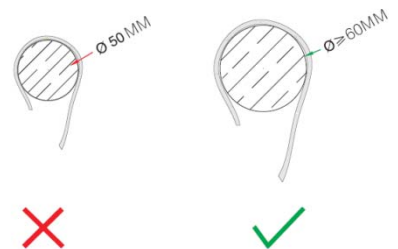

03 No winding an object with a diameter <5cm

Troubleshooting:

Malfunctions	Possible Causes	Solutions
All LEDs don't work	1. The power supply did not connect to power grid.	Power on
	2. No electricity due to short-circuit of external power supply.	Remove the malfunction caused by short-circuit, power on again.
	3. The wires of strips connect to power supply output reversely.	Check the connecting and ensure the wires are connected correctly.
Part of LEDs don't work	1. Part of power supplies do not have output.	Check the power supply system.
	2. Part of wires of strips have malfunction.	
	3. Particular modules connected reversely.	Correct connection
Brightness of LEDs is weak or uneven	1. Overloaded power supply;	Replace it with higher power supply
	2. The power loss of power circuit is huge or the power loss of each circuit existing big difference.	Ensure working voltage of strips is within $\pm 5\%$ V of rated voltage. 1. Shorten the length of wires between the first strip and power supply or replaced with wires with bigger diameter; 2. Ensure the cascading qty of string is less than or equal to the allowed maximum cascading qty, and each strip cascading qty is well-balanced.)
	3. Exceed in qty of strips in series	Lessen the cascading qty for strip and ensure the qty for each electrical circuit is within the maximum cascading qty.
LEDs are blinking	1. Poor contacted in the joints.	Find out and tackle malfunction immediately.
	2. Failures in power supply.	Replace power supply.

Declaration:

- ⊙ If the external flexible cable of light box is damaged, please replace it by its manufacturer or its service agent or qualified person to avoid a hazard.
- ⊙ The specific installation and cautions please refer to the user manual.
- ⊙ The given data in this specification is based on our standard product. There may be existed slight difference compared with actual products.
- ⊙ All Illustrations in this specification are for reference only.
- ⊙ This product is subject to change or modify without prior notice.
- ⊙ RISHANG OPTOELECTRONICS CO., LTD reserves the right of final explanation for this specification.

<End>

Rishang Optoelectronics Co., Ltd (stock code: 002654)

Add: Block 2, Hongfa jiateli High-Tech. Park Tangtou Ave., Shiyan, Bao'an Shenzhen

Tell: +86-755-36988588 E-mail: info@ledlamps.com.cn

Website: www.ledlamps.com.cn



Website

WeChat Account

